

## VARIABLE CAPACITANCE DIODE

### FEATURES

- Very Small SRD Surface Mount Package
- Very Low Operating Voltage (1 to 4 V)
- Large Capacitance Ratio (A = 3.4)
- Excellent Linearity (CV Curve)
- Very Small Capacitance Deviation at Tape/Reel
- Very Low Series Resistance

### DESCRIPTION

The KV1832C is a variable capacitance diode designed for UHF applications.

The KV1832C is available in a very small SRD Surface Mount Package.

### APPLICATIONS

- Communications Equipment
- Multi-Channel Cordless Telephone
- Voltage Controlled Oscillator
- UHF Wireless Communication Systems

### CLASSIFICATION

Unit: pF

C		RANK				
		1A	2A	3A	4A	5A
C <sub>2</sub>	MIN	8.5	9.05	9.75	10.55	11.25
	MAX	9.15	9.85	10.65	11.35	11.90

Note: Rank is determined after testing and marked on the reel. All the diodes on a reel have the same rank, but rank can not be specified when ordering.

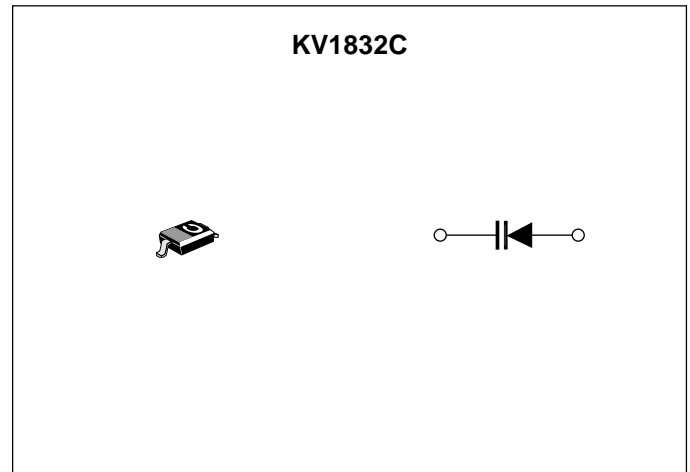

### ORDERING INFORMATION

KV1832C    
 Tape/Reel Code

TAPE/REEL CODE  
 TR: Tape Right

# KV1832C

---

## ABSOLUTE MAXIMUM RATINGS

Reverse Voltage ..... 28 V  
Forward Current ..... 10 mA  
Power Dissipation ..... 50 mW

Storage Temperature Range ..... -55 to +150 °C  
Operating Temperature Range ..... -55 to +85 °C

## ELECTRICAL CHARACTERISTICS

Test conditions:  $T_A = 25\text{ °C}$

SYMBOL	PARAMETER	TEST CONDITIONS	MIN	TYP	MAX	UNITS
$V_{REV}$	Reverse Voltage	$I_{REV} = 10\ \mu\text{A}$	20			V
$I_{REV}$	Reverse Current	$V_{REV} = 16\ \text{V}$			5.0	nA
$C_1$	Diode Capacitance 1	$V_{REV} = 1\ \text{V}, f = 1\ \text{MHz}$	15.40	16.60	17.90	pF
$C_2$	Diode Capacitance 2	$V_{REV} = 2\ \text{V}, f = 1\ \text{MHz}$	8.50	10.20	11.90	pF
$C_4$	Diode Capacitance 4	$V_{REV} = 4\ \text{V}, f = 1\ \text{MHz}$	3.60	4.30	5.05	pF
$R_S$	Series Resistance	$C = 7\ \text{pF}, f = 470\ \text{MHz}$			0.7	$\Omega$
A	Capacitance Ratio	$C_1 / C_4$	3.40			

Note 1: Diode Capacitance measured with HP 4279A or equivalent instruments (at OSC level 20 mVrms,  $\pm 5\ \text{mVrms}$ ).

Note 2: Series Resistance measured with HP 4191A or equivalent instruments.

## TYPICAL PERFORMANCE CHARACTERISTICS

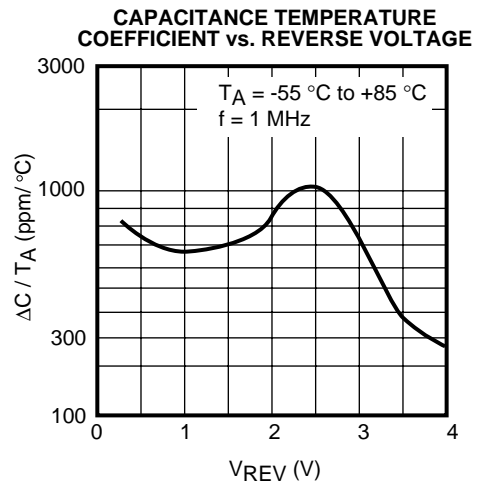
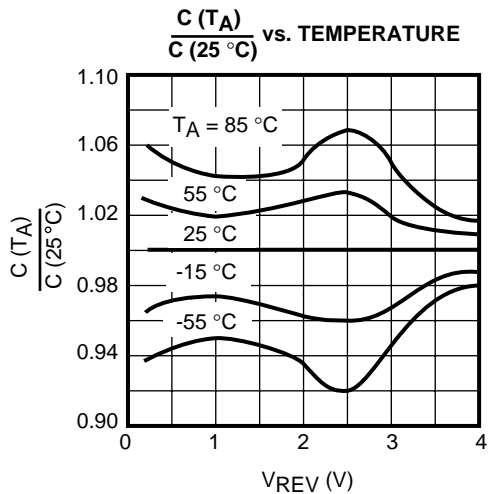
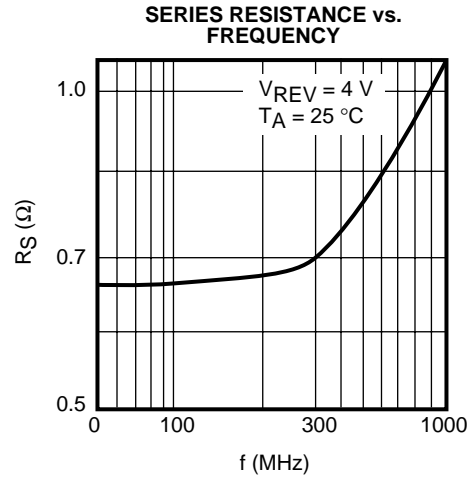
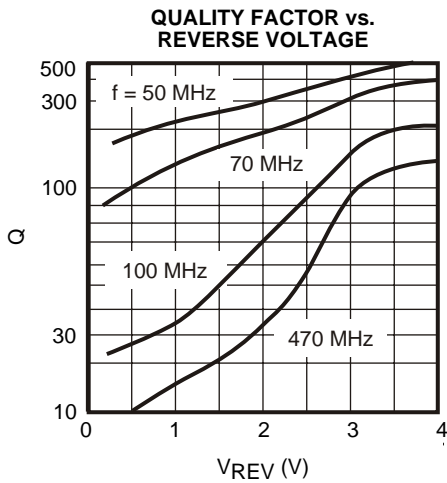
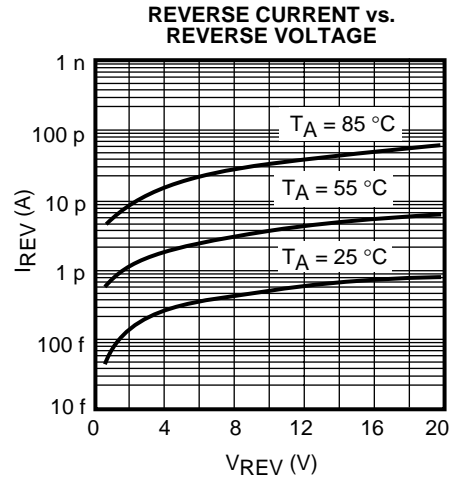
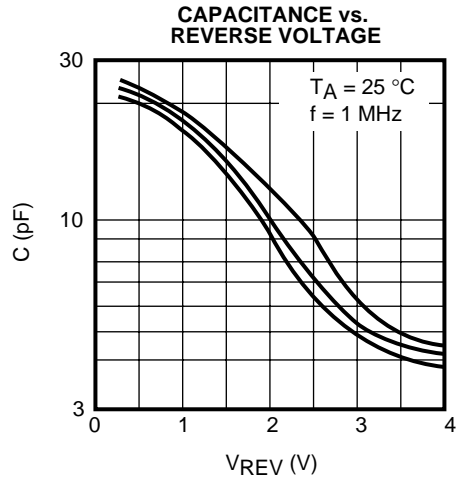

## PACKAGE OUTLINE

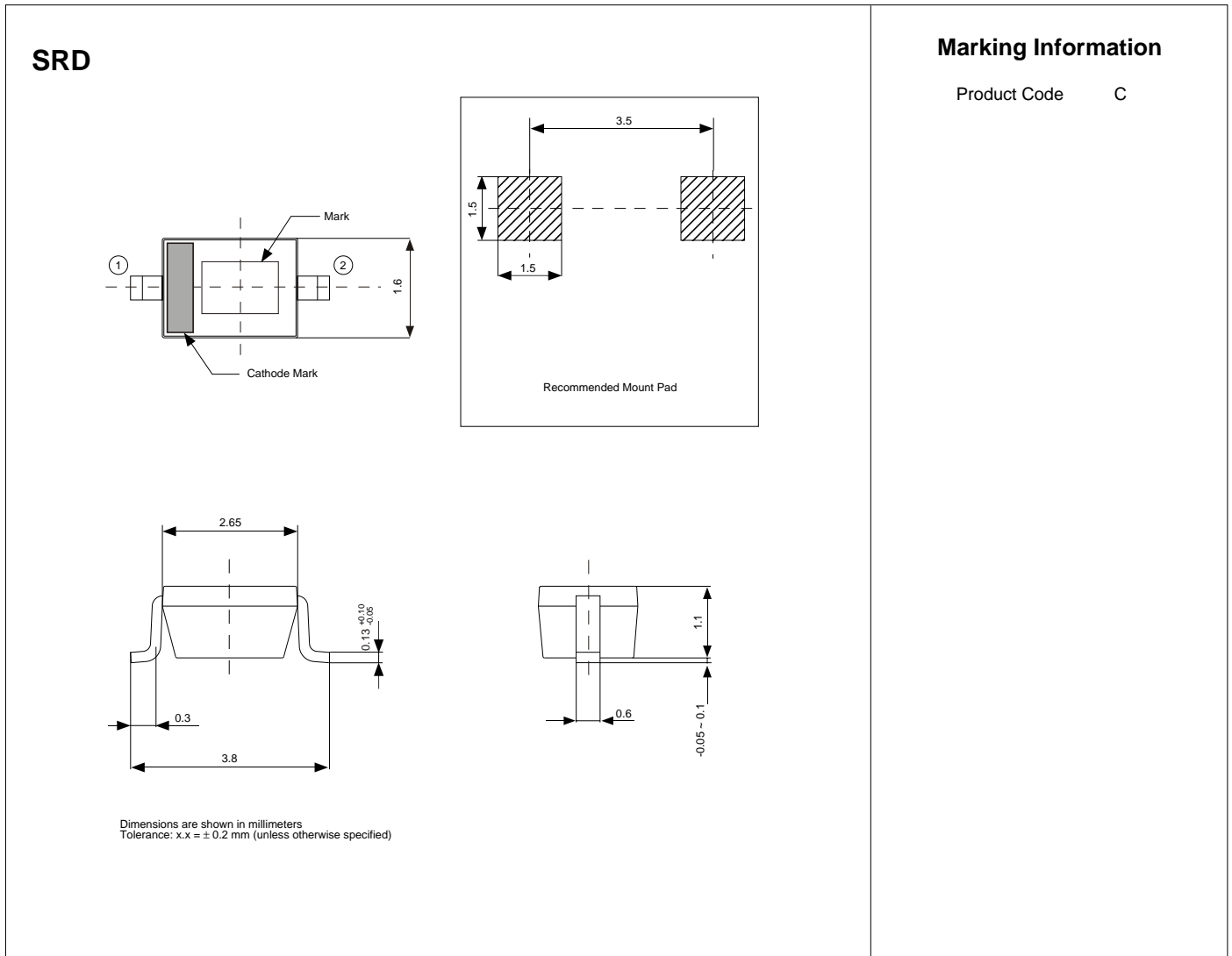

**Toko America, Inc. Headquarters**  
 1250 Feehanville Drive, Mount Prospect, Illinois 60056  
 Tel: (847) 297-0070 Fax: (847) 699-7864

### TOKO AMERICA REGIONAL OFFICES

**Midwest Regional Office**  
 Toko America, Inc.  
 1250 Feehanville Drive  
 Mount Prospect, IL 60056  
 Tel: (847) 297-0070  
 Fax: (847) 699-7864

**Western Regional Office**  
 Toko America, Inc.  
 2480 North First Street, Suite 260  
 San Jose, CA 95131  
 Tel: (408) 432-8281  
 Fax: (408) 943-9790

**Eastern Regional Office**  
 Toko America, Inc.  
 107 Mill Plain Road  
 Danbury, CT 06811  
 Tel: (203) 748-6871  
 Fax: (203) 797-1223

**Semiconductor Technical Support**  
 Toko Design Center  
 4755 Forge Road  
 Colorado Springs, CO 80907  
 Tel: (719) 528-2200  
 Fax: (719) 528-2375

Visit our Internet site at <http://www.tokoam.com>

The information furnished by TOKO, Inc. is believed to be accurate and reliable. However, TOKO reserves the right to make changes or improvements in the design, specification or manufacture of its products without further notice. TOKO does not assume any liability arising from the application or use of any product or circuit described herein, nor for any infringements of patents or other rights of third parties which may result from the use of its products. No license is granted by implication or otherwise under any patent or patent rights of TOKO, Inc.